

0+360

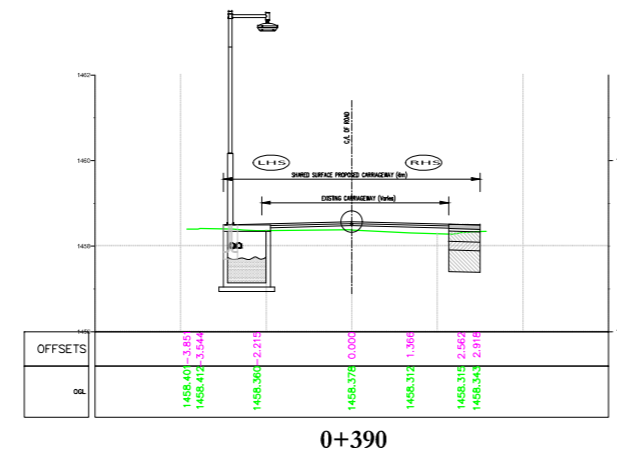

0+390

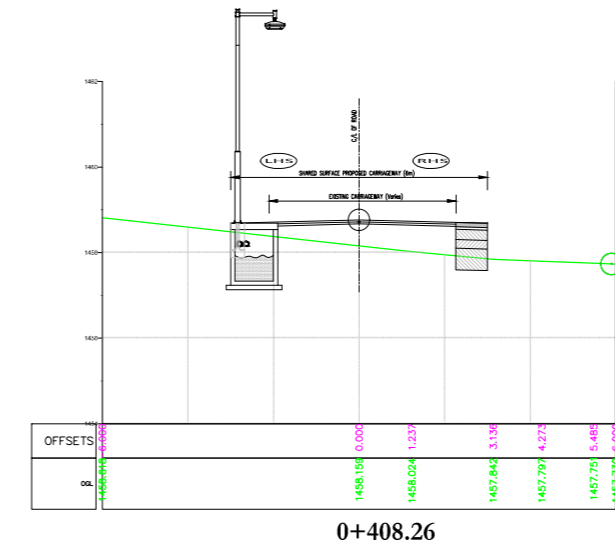

0+408.26

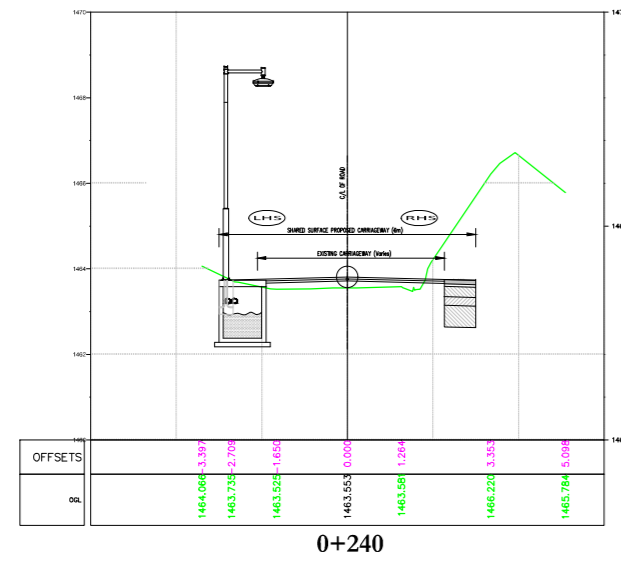

0+240

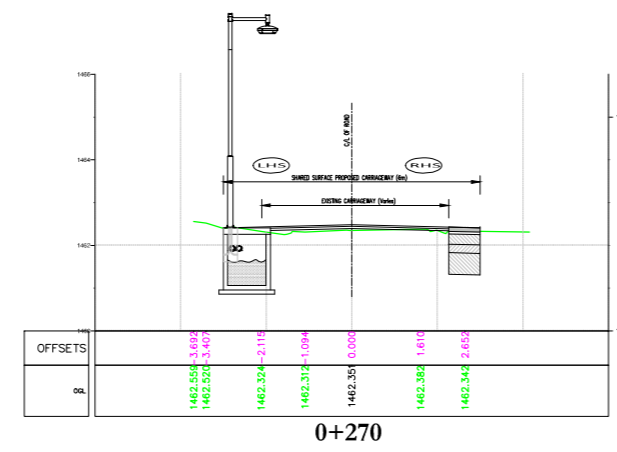

0+270

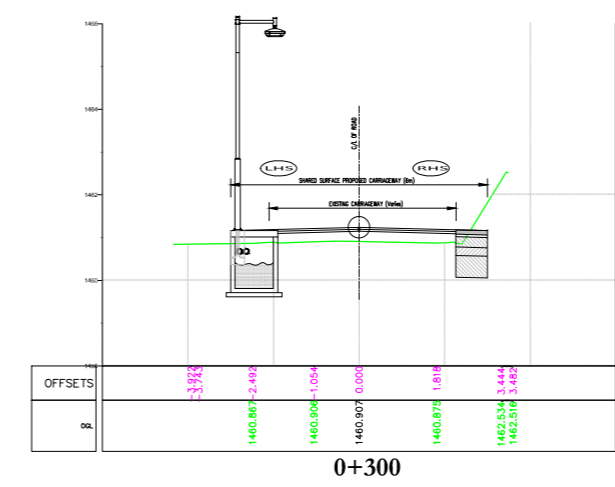

0+300

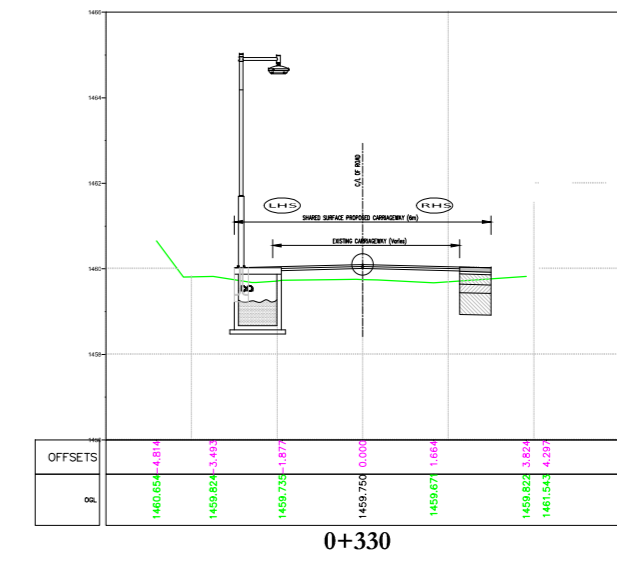

0+330

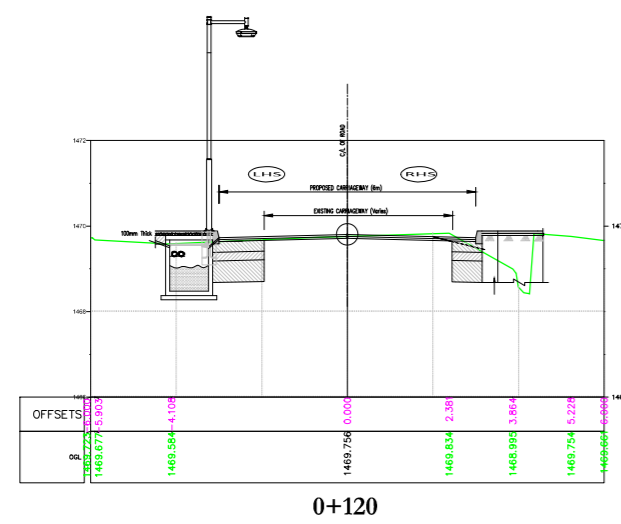

0+120

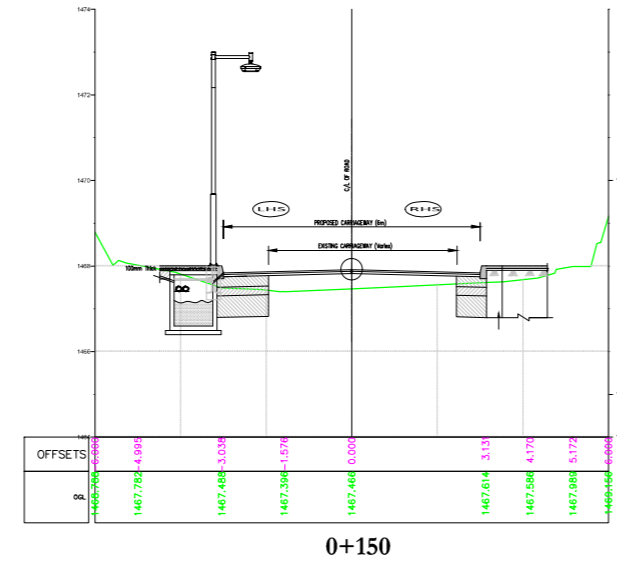

0+150

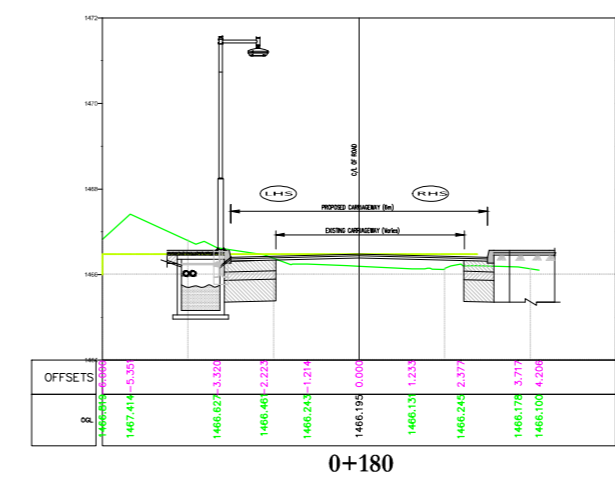

0+180

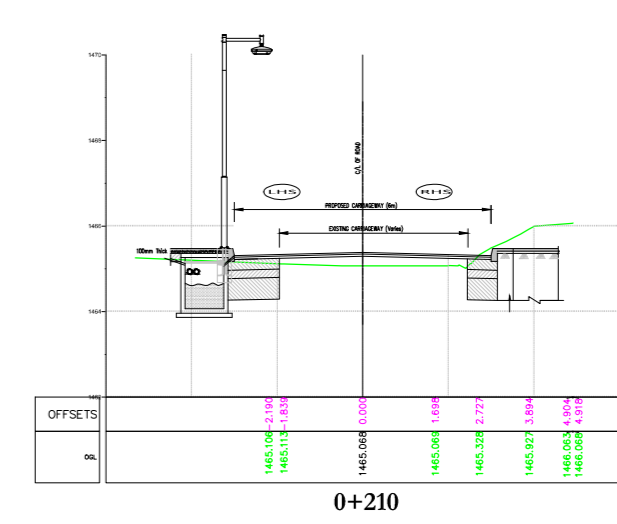

0+210

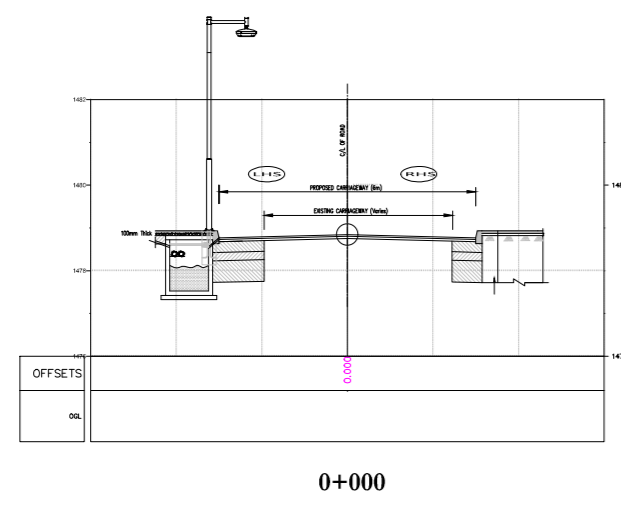

0+000

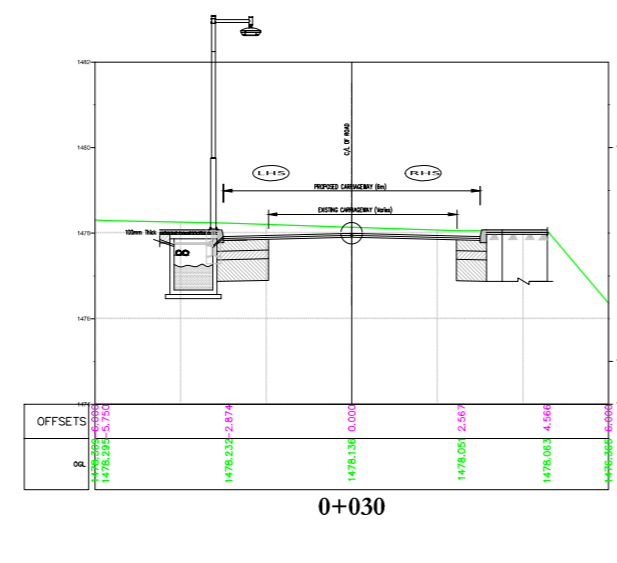

0+030

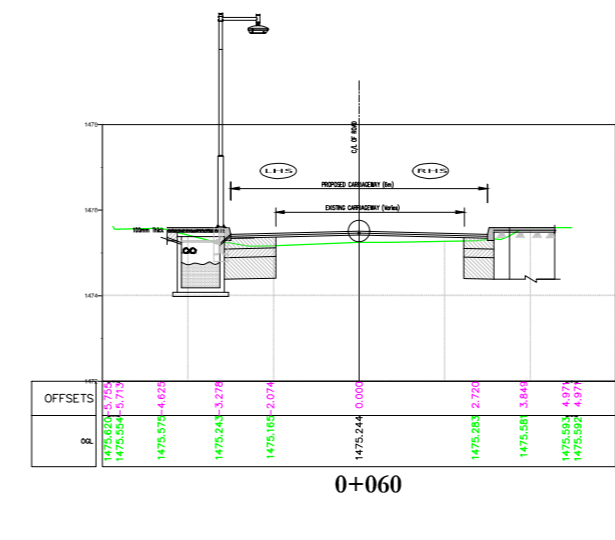

0+060

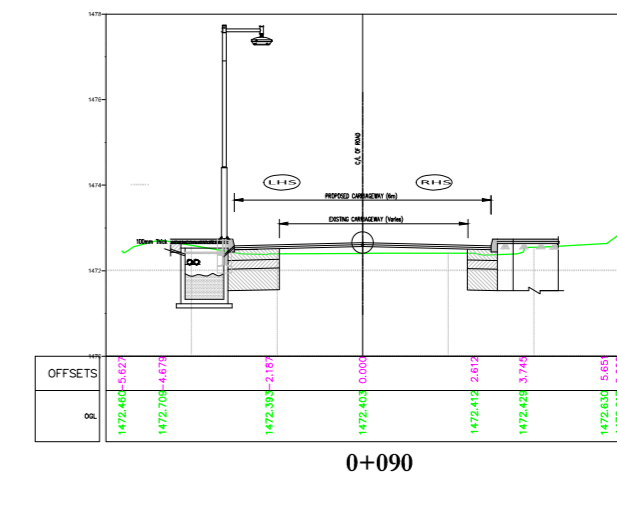

0+090

DRAWINGS ARE FOR TENDER PURPOSES ONLY

Rev	dd/mm/yyyy	Description	Rev by	dd/mm/yyyy

Designed : IPEG
 Checked :
 Approved :

Client
SHILLONG SMART CITY LIMITED

Submitted By

 Expanding Horizons. Enriching Lives.

Project:
DEVELOPMENT OF SMART ROAD IN SHILLONG
 Drg Title:
(RD-02) CROSS SECTIONS
(From STA : 0+000 to STA : 0+408.26)

Drg No : RD-2/CS-02
 Scale : NTS
 Date : 10.02.2020
 Contract No. :
 Rev R0

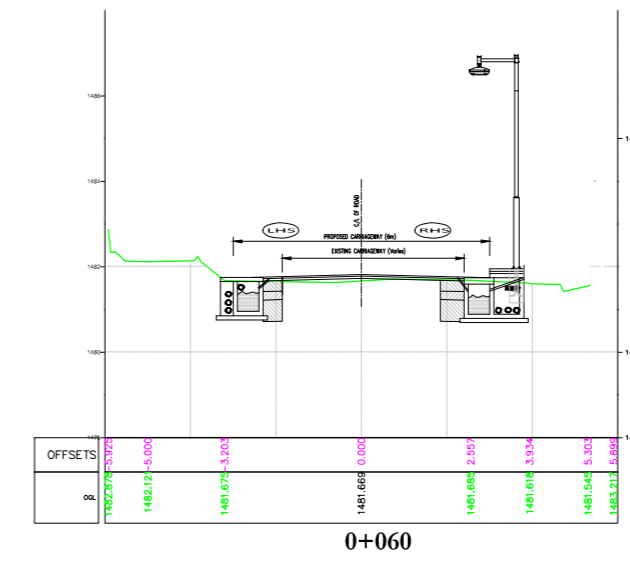
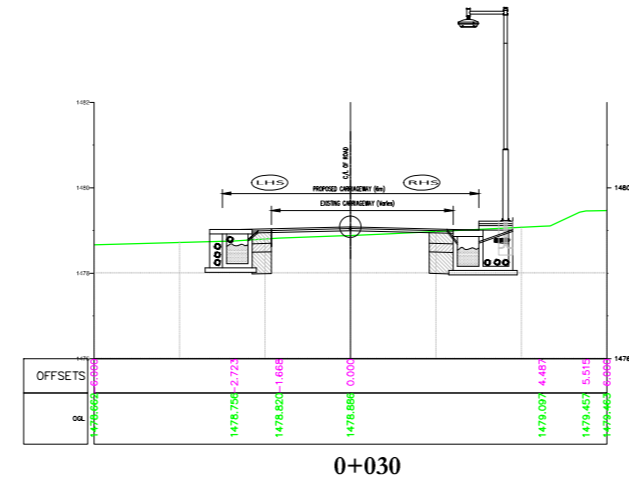
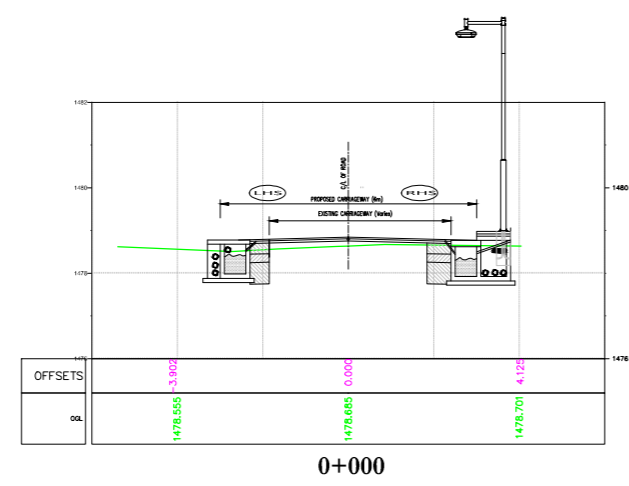
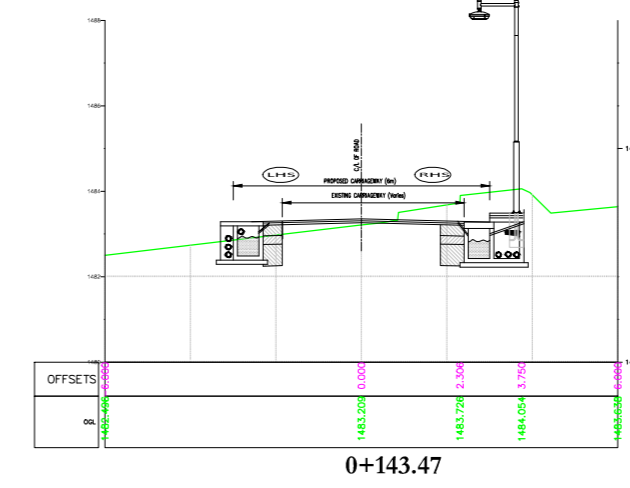
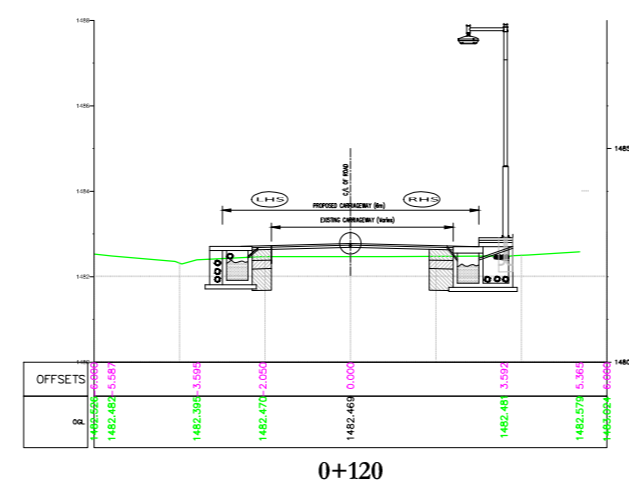
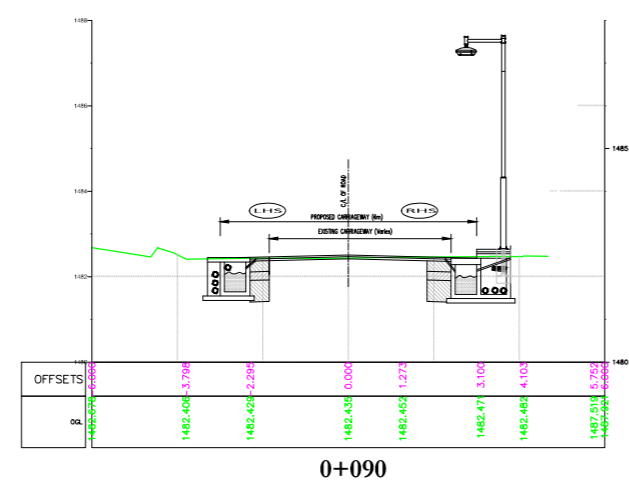

DRAWINGS ARE FOR TENDER PURPOSES ONLY

Rev	dd/mm/yyyy	Description	Rev by	dd/mm/yyyy

Designed : IPEG
 Checked :
 Approved :

Client
SHILLONG SMART CITY LIMITED

Submitted By

 Expanding Horizons. Enriching Lives.

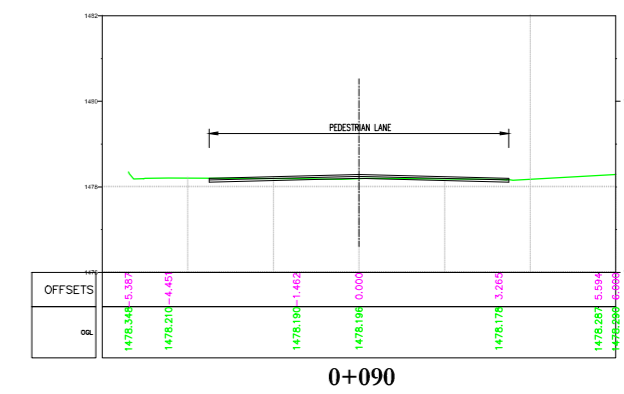
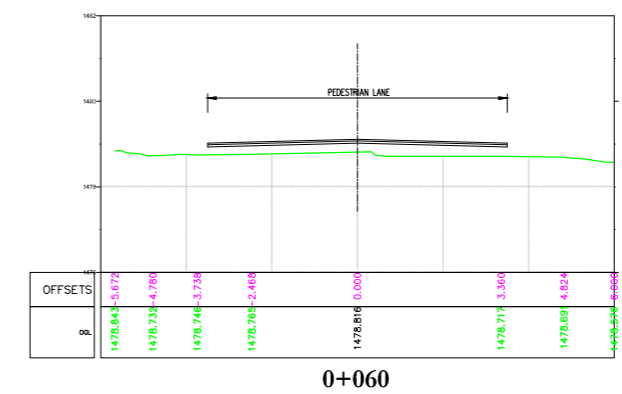
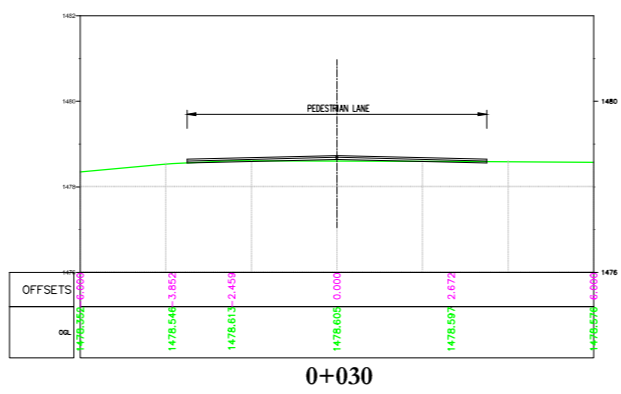
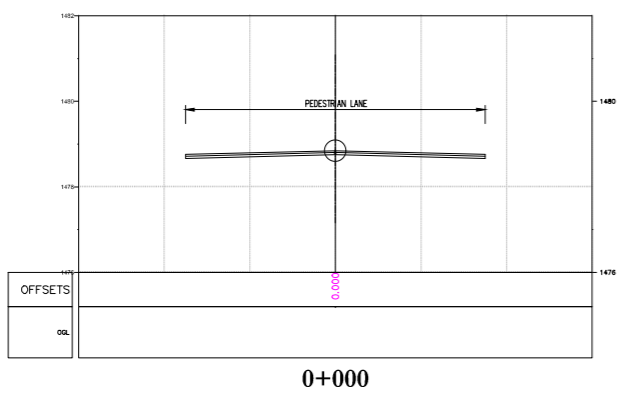
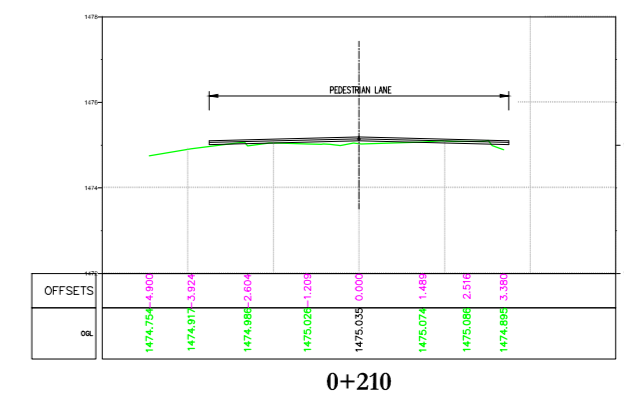
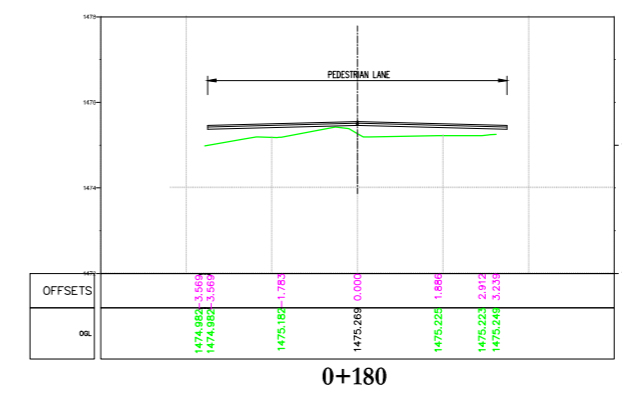
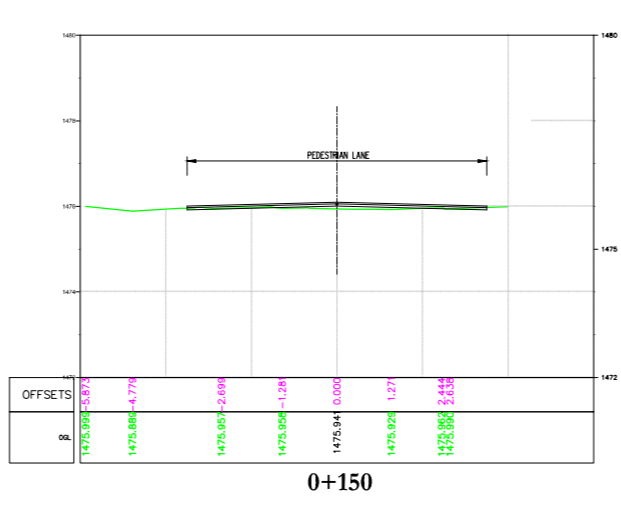
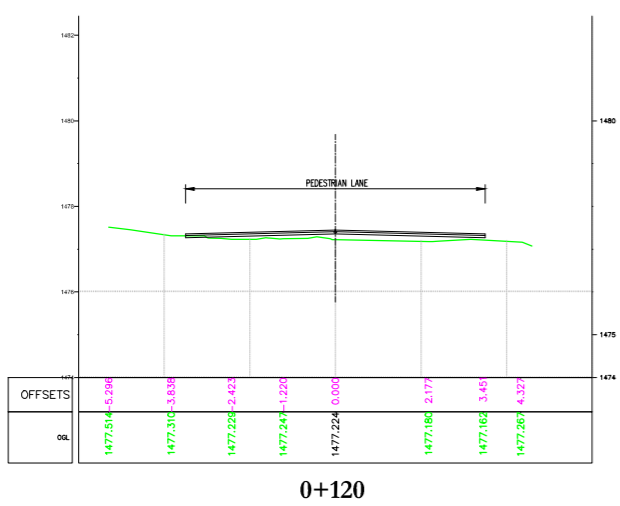
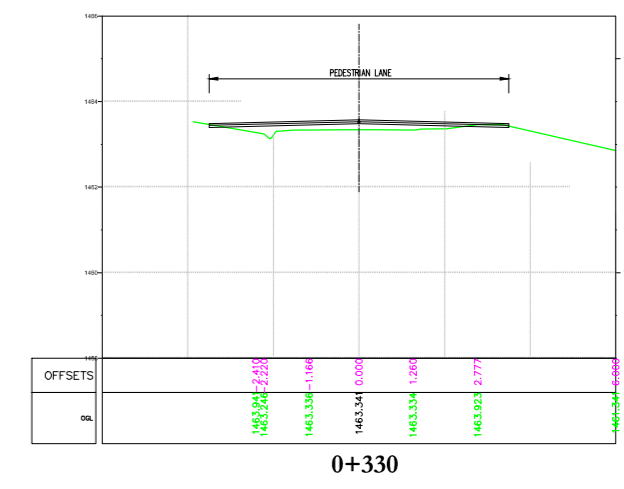
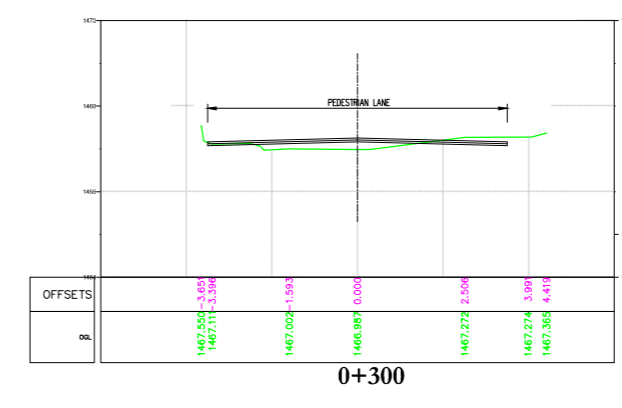
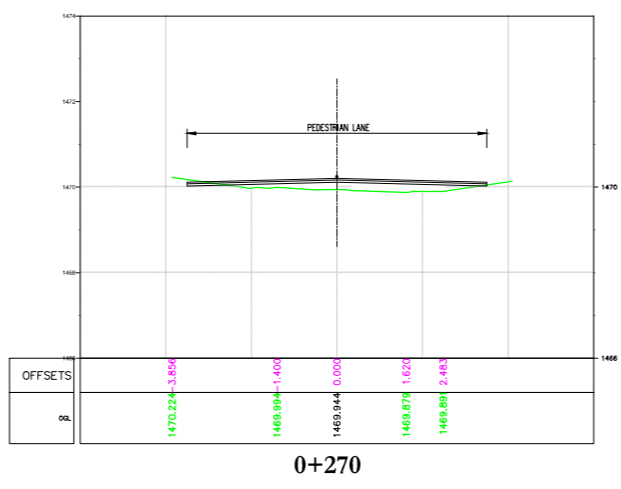
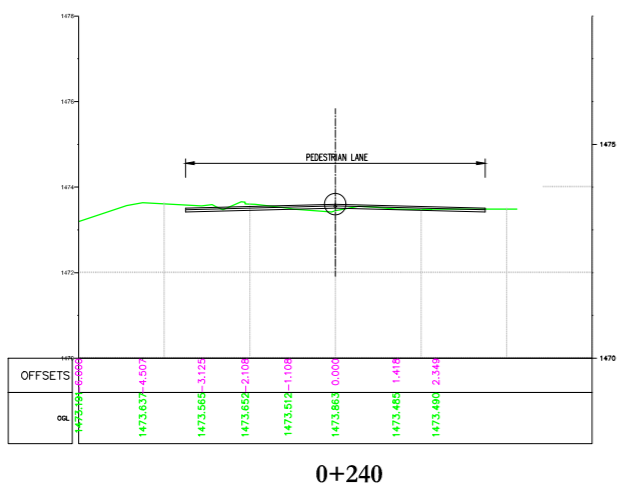
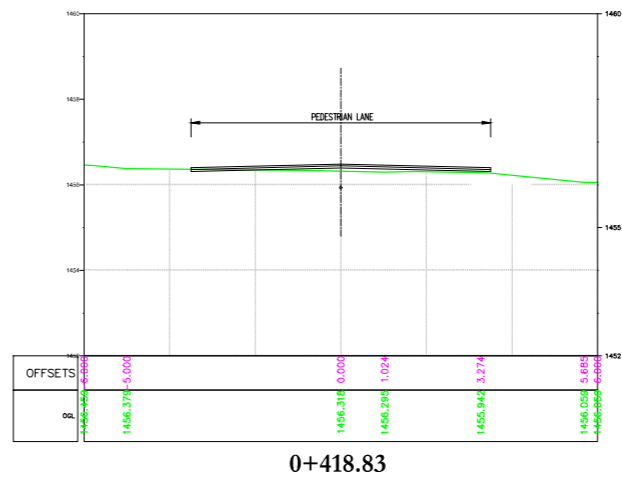
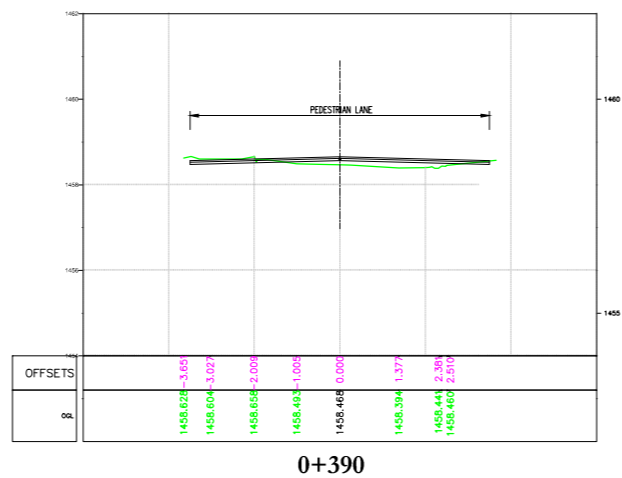
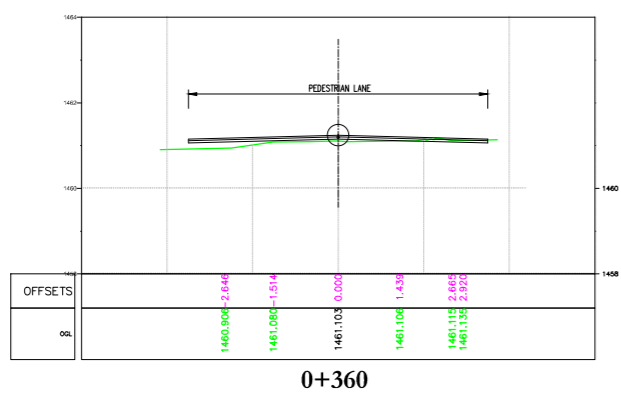

Project:
 DEVELOPMENT OF SMART ROAD IN SHILLONG
 Drg Title:
 (RD-03)
 CROSS SECTIONS
 (From STA : 0+000 to STA : 0+143.47)

Drg No :	RD-3/CS-03
Scale :	NTS
Date :	10.02.2020
Contract No. :	
Rev	RO



DRAWINGS ARE FOR TENDER PURPOSES ONLY

Rev	dd/mm/yyyy	Description	Rev by	dd/mm/yyyy

Designed : IPEG
 Checked : 
 Approved : 

Client
SHILLONG SMART CITY LIMITED

Submitted By

 Expanding Horizons. Enriching Lives.

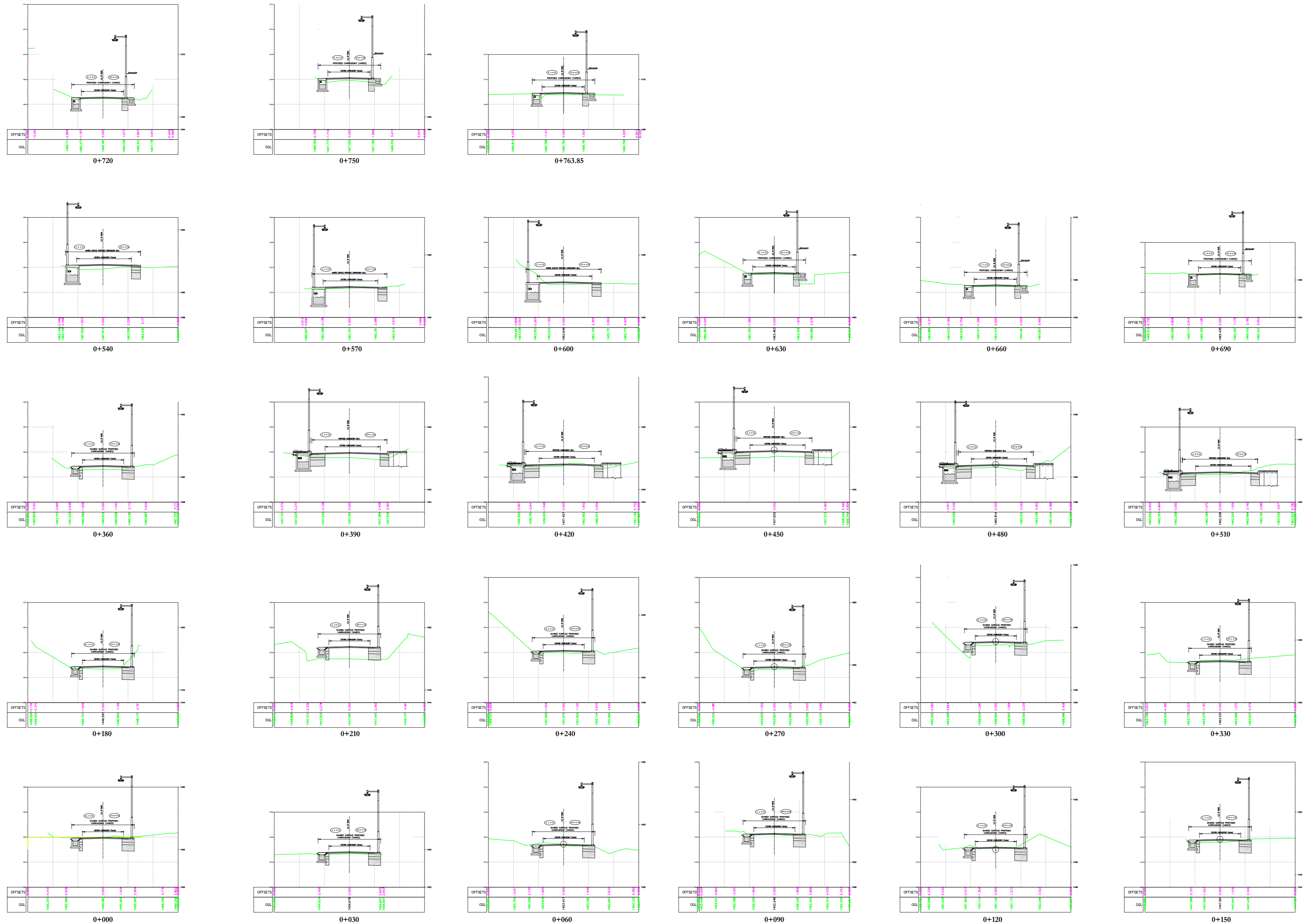

Project:
 DEVELOPMENT OF SMART ROAD IN SHILLONG
 Drg Title:
 (RD-04)
 CROSS SECTIONS
 (From STA : 0+000 to STA : 0+418.83)

Drg No : RD-4/CS-04
 Scale : NTS
 Date : 10.02.2020
 Contract No. :
 Rev : R0



DRAWINGS ARE FOR TENDER PURPOSES ONLY

Rev	dd/mm/yyyy	Description	Rev by	dd/mm/yyyy

Designed : IPEG
 Checked : 
 Approved : 

Client
SHILLONG SMART CITY LIMITED

Submitted By

 Expanding Horizons. Enriching Lives.

Project:
DEVELOPMENT OF SMART ROAD IN SHILLONG
 Drg Title:
**(RD-06)
 CROSS SECTIONS
 (From STA : 0+000 to STA : 0+206.46)**

Drg No : RD-6/CS-06
 Scale : NTS
 Date : 10.02.2020
 Contract No. :
 Rev : R0